

# MALMBERGS

## EVON DUAL

### WiFi/Bluetooth/4G

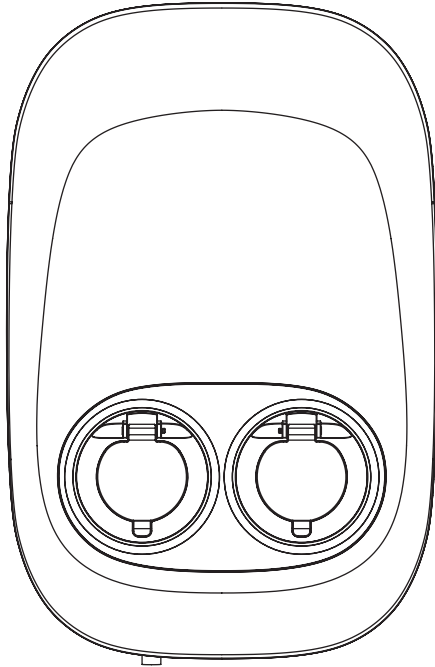

---

**EN** NOTE! Please read through the manual carefully before using the appliance and keep it for future reference.



# WiFi Charging Station for Electric Vehicles

## Content

1	ABOUT THIS MANUAL	4
1.1	Function of this manual	4
1.2	Disclaimer	4
1.3	Abbreviations	4
2	SAFETY AND WARNINGS	5
3	PRODUCT OVERVIEW	6
4	TECHNICAL SPECIFICATIONS	7
5	INSTALLATION	8-11
5.1	Check upon delivery	8
5.2	Install the back plate	9
5.3	Connect power cable	9
5.4	Connect network cable and insert SIM card	10
5.5	Plug the core box into the back plate	11
6	CONFIGURE NETWORK	11-13
7	CONDUCT A FUNCTION TEST	13
8	CONNECT THE CHARGING STATION TO EVCHARGO CLOUD	14
9	USE EVCHARGO APP TO CHARGE ELECTRIC VEHICLE	14
10	TROUBLESHOOTING	15

# 1 ABOUT THIS MANUAL

## 1.1 Function of this manual

This document is only applicable for this Evon dual series charging station.

The document gives the information that is necessary to safely do these tasks:

- Install the charging station
- Use the charging station
- Do basic maintenance tasks

## 1.2 Disclaimer

Malmbergs shall not be liable for any damages, losses, costs or expenses resulting from the improper handling of the charging station, in particular resulting from noncompliance with the instructions of this document and other applicable regulations and standards (e.g. installation, transport, occupational health and other safety standards).

## 1.3 Abbreviations

Abbreviation	Definition
AC	Alternating current
EMC	Electromagnetic compatibility
EV	Electric vehicle
OCPP	Open charging station protocol
PE	Protective earth
RFID	Radio-frequency identification
LBC	Load Balance Controller
RCBO	Residual current circuit breaker

## 2 SAFETY AND WARNINGS

### Caution

- Failure to follow instructions may result in danger.
- Children are prohibited from touching the charging station.
- Do not disassemble the charging station while connected to the mains.
- Install the charging station away from pyrotechnics, dusty or corrosive places.
- Only use the charging station when it is operating normally and please strictly follow the instructions.
- The charging station produces high-voltage output. You must pay attention to your personal safety when using it.
- If a malfunction happens, it may cause electric shock or even death. In emergency situations, cut off the power supply..

### Maintenance/Installation

- Maintenance and installation must be performed by a qualified electrician.
- The product is carefully packed in the factory. During transportation, strong impact and bumps should be avoided to prevent damage to the outer packaging of the product.
- The product should be installed in an environment with an ambient temperature of  $-30^{\circ}\text{C} - +50^{\circ}\text{C}$  and with a relative humidity of no more than 95%. The air should not contain acids, alkalis or other corrosive or explosive gases.

### Safety Warning

#### Failure to follow instructions may result in danger!

- Regularly check whether the charging station has visible damage. There may be an electric shock hazard when operating a broken charging station.
- If a ground fault occurs, it must be assumed that the cable carries voltage. Please confirm that there's no high-voltage power in the system before inspecting the charging.
- Persons who install and use charging stations must obey the principles and regulations mentioned to ensure the personal safety and equipment safety.
- Before powering on the device, please confirm that the device is properly grounded to avoid unnecessary accidents.
- Under any circumstances, do not open, modify or install the device yourself.
- To ensure the service life and stable operation of the charging station, the operating environment should be kept as clean as possible with a relatively stable temperature and humidity. The charging station must not be used in flammable environment or environments with volatile gas.
- Please confirm that the input voltage, frequency, circuit breakers and other conditions of the device meet the specifications before the device is powered on.
- The device will stop charging automatically for safety whenever a leakage current is detected. You can start another charging session after the RCBO is reset.
- Cord extension sets are not allowed to be used.
- Adapters or conversion adapters are not allowed to be used.

### 3 PRODUCT OVERVIEW

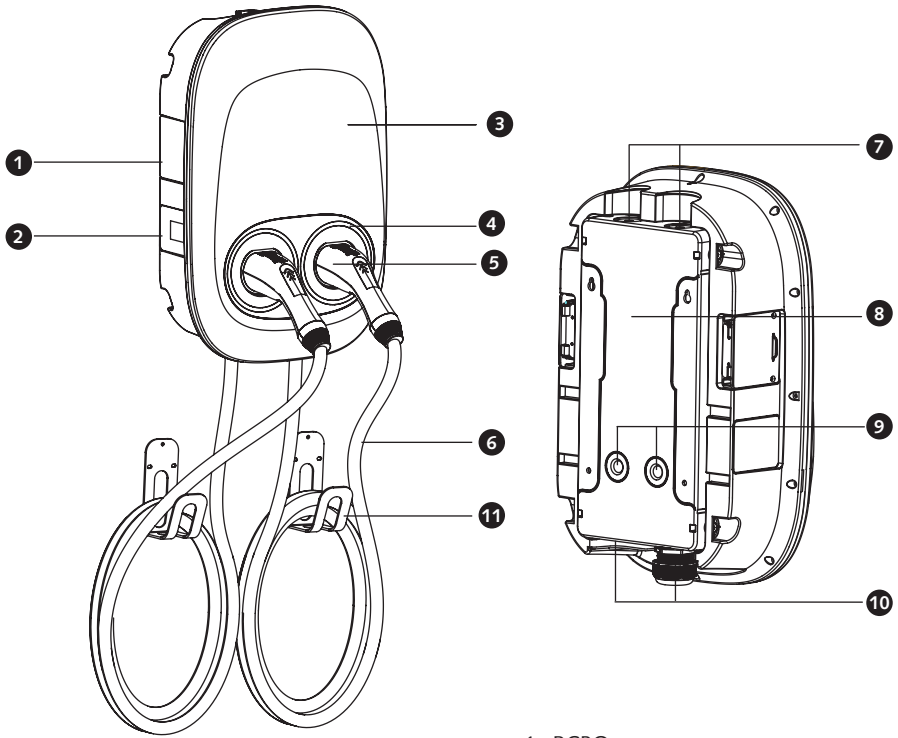

**Cable version: 27 006 78-79**

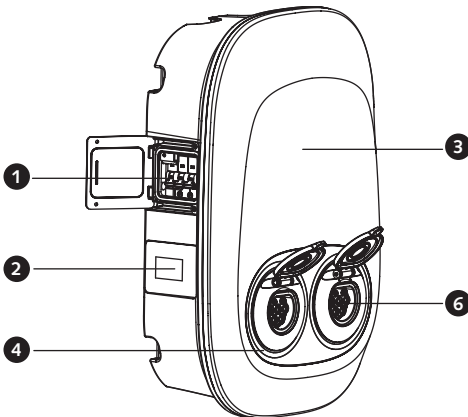

**Socket version: 27 006 31, 77**

1. RCBO
2. Energy meter
3. Charging station
4. LED indicator
5. Charging connector
6. Charging cable/Charging socket
7. Power cable inlet/outlet (top side)
8. Back plate
9. Power cable inlet'outlet (rear side)
10. Power cable inlet/outlet (bottom side)
11. Cable holder

Note: press the "Reset" button for 5s, and you can reset the PIN code in the AP mode network configuration.

#### 4 TECHNICAL SPECIFICATIONS

	Art.no.	27 006 31	27 006 77	27 006 78	27 006 79
<b>Input</b>	Power Supply	3P+N+PE			
	Rated Voltage	400V AC			
	Rated Current	32A			
	Frequency	50/60Hz			
<b>Output</b>	Output Voltage	400V AC			
	Maximum Current	32A			
	Output Power	2x11kW/1x22kW			
<b>User Interface</b>	Connector Type	2xType 2 Socket		2xType 2 Cable	
	Charging Cable	/		7 m	
	Enclosure	PC			
	LED Indicator	Green/Yellow/Red			
	RFID Reader	Support			
	Start Mode	Plug&Charge/RFID Card/App			
	Charging Mode	Mode 3			
<b>Communication</b>	WiFi	Wi-Fi 802.11 b/g/n 2.4 GHz (2412-2472 MHz)			
	4G	4G LTE Cat-1 LTE FDD: B1/B3/B5/B7/B8/B20/B28			
	Ethernet	Yes			
	Bluetooth	Bluetooth Low Energy (BLE 4.1) 2402-2480 MHz (for installer configuration purposes)			
	OCPP	OCPP1.6 Json(OCPP2.0 Upgradable)			
<b>Safety</b>	RCBO	40A Type A			
	RCD	30mA AC+6mA DC			
	Meter	With MID meter	Without MID meter	With MID meter	Without MID meter
	Ingress Protection	IP54			
	Impact Protection	IK10			
	Electrical Protection	Over current protection, Residual current protection, Short circuit protection, Surge protection, Over/Under voltage protection, Over/Under frequency protection, Over temperature protection			
	Type of Protection Against Electric Shock	Class I equipment			
	Pollution Degree	3			
	EMC Class	Class B			
	Grounding system support	TT, TN, IT			
<b>Environment</b>	Installation	Wall-mounted/ Pedestal-mounted			
	Working Temperature	- 30°C - +50°C			
	Working Humidity	5%~95%			
	Working Altitude	<2000 m			
<b>Package</b>	Product Dims (WxHxD)	369x559x197 mm			
	Package Dims (WxHxD)	466x620x245 mm		630x345x430 mm	
	Net Weight	9.7 kg	8.7 kg	19.4 kg	17.4 kg



A Circuit Breaker (MCB) installed at source is recommended.

**EMC Standard (EMC)**

EN IEC 61851-21-2: 2021

**Safety Standard (LVD)**

EN IEC 61851-1: 2019

**RoHS Standard (RoHS)**

IEC 62321-2:2021, IEC 62321-1:2013,  
IEC 62321-3-1:2013, IEC 62321-4:2013+A1:2017,  
IEC 62321-5:2013, IEC 62321-7-1:2015,  
IEC 62321-7-2:2017, IEC 62321-6:2015,  
IEC 62321-8:2017

**RF & Health**

EN 300 328 V2.2.2:2019, EN 300 330 V2.1.1:2017,  
EN 301 489-1 V2.2.3:2019, EN 301 489-3 V2.1.1:  
2019, EN 301 489-17 V3.2.0:2017, EN 62311:2020

**REACH**

1907/2006, REACH etc. (Amendment) Regulations  
2021

**AC cable requirement**

Cable with a cross-sectional area of 16–25 square  
millimetres meeting VDE is highly recommended,  
with temperature resistance above 105°C.

**DECLARATION OF CONFORMITY**

We hereby certify that the device satisfies the provisions  
for CE marking in accordance with the EU directives (LV  
Directive 2014/35/EU, EMC Directive 2014/30/EU, RE  
Directive 2014/53/EU, RoHS Directive 2011/65/EU,  
(EU) 2015/863) as described in this manual.

For and on behalf of:

*Anders Folke*

Malmbergs Elektriska AB, Sweden.  
Mr. Anders Folke / Product Manager  
Date: 08/04/2024



**CE RoHS REACH**

**5 INSTALLATION**

**5.1 Check upon delivery**

Check the box upon receiving the charging station to ensure you have the following parts:

Socket version: 27 006 31, 77



Cord end terminal  
(x12)

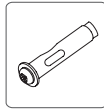

Anchor bolt  
(x4)

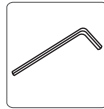

L-shaped wrench  
(x1)



Charging station  
(x1)

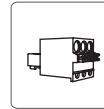

RS485 cable terminals  
(x2)



Cable clip  
(x2)



M6x16 screw  
(x4)



Gland  
(x1)



Cable rubber cover  
(x2)

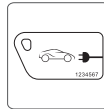

RFID card  
(x4)

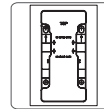

Installation diagram  
(x1)

Cable version: 27 006 78-79

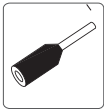

Cord end terminal  
(x12)



Anchor bolt  
(x4)



L-shaped wrench  
(x1)



Cable holder  
(x2)



Charging station  
(x1)

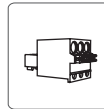

RS485 cable  
terminals (x2)



Cable clip  
(x2)

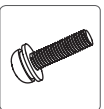

M4x16 screw  
(x4)



Cable rubber cover  
(x2)



Gland  
(x1)

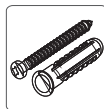

Wall plug (x6) /  
wall mounting screw (x6)

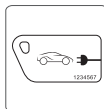

RFID card  
(x4)

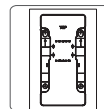

Positioning diagram  
(x1)



If you are missing any of these parts, please contact us.



## 5.2 Install the back plate

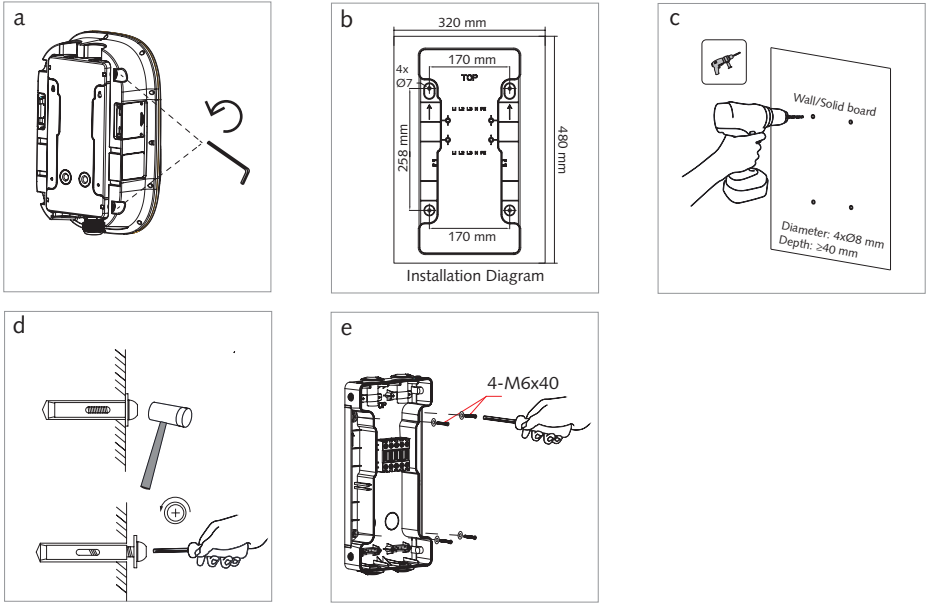

## 5.3 Connect power cable

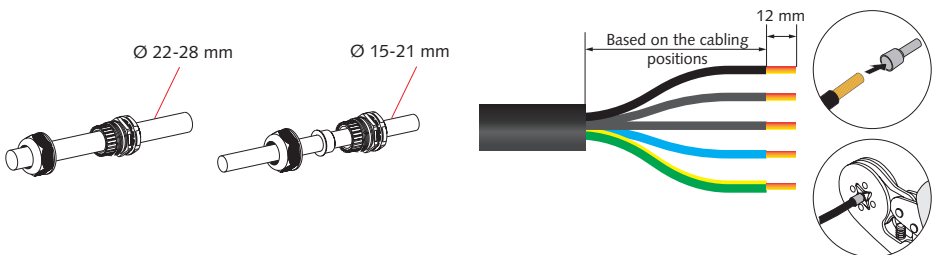
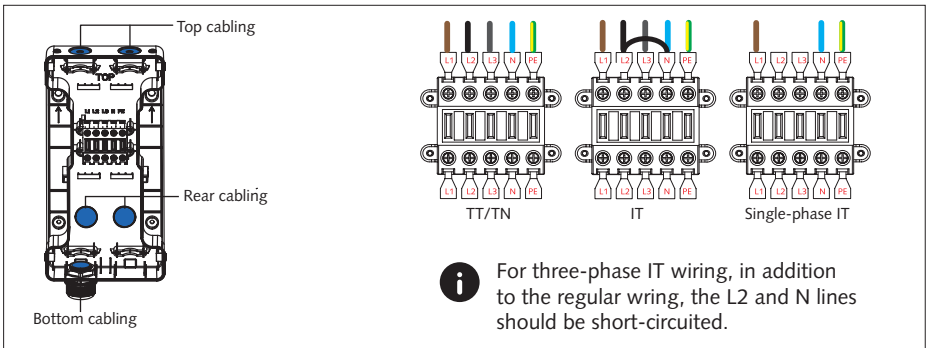

**Method 1: Series Connection (Max. 100A)**

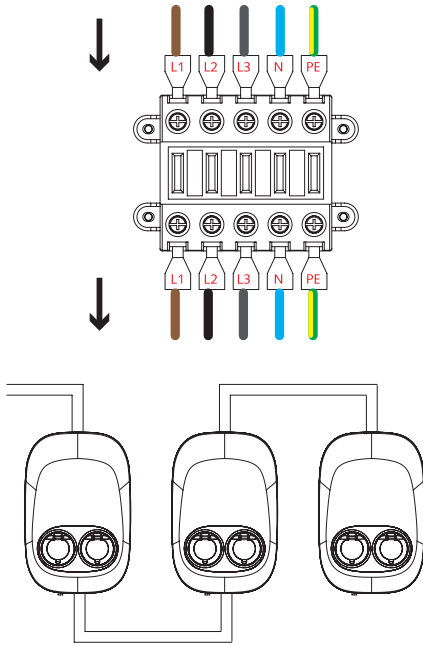

**Method 2: Parallel Connection**

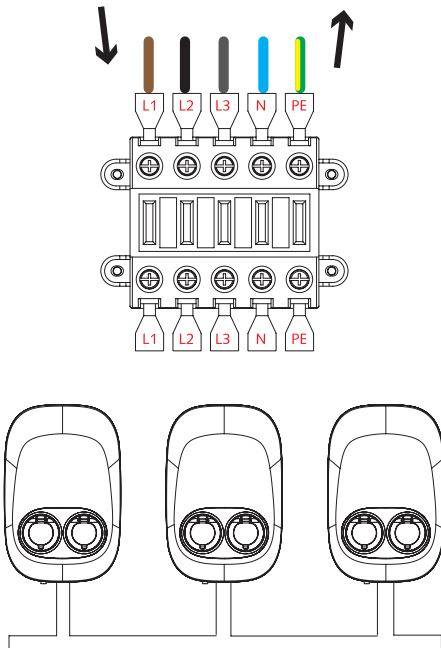

**5.4 Connect network cable**

Connect RS485 cable  
Insert SIM card

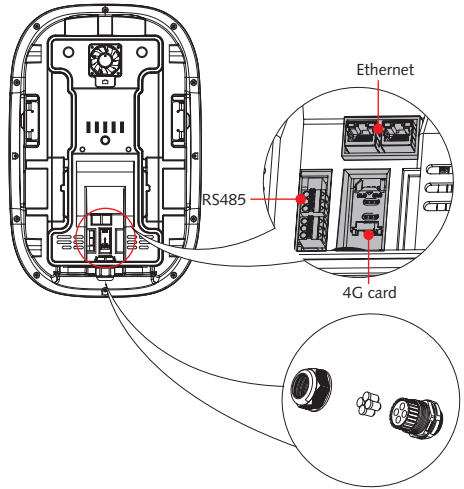

Ethernet cable:

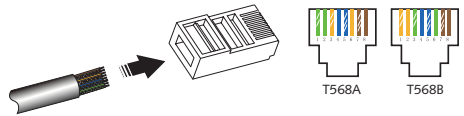

RS485 cable:

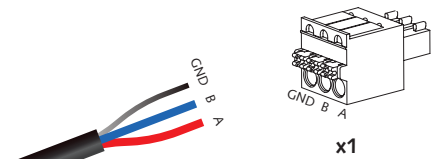

SIM card:

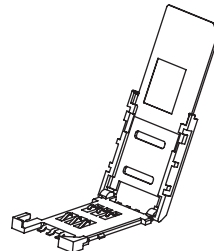

### 5.5 Plug the core box into the back plate

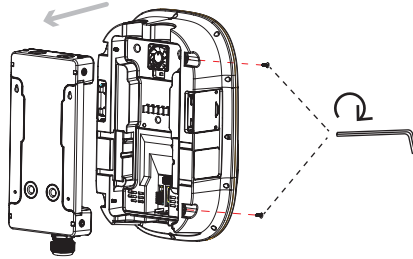

## 6 CONFIGURE NETWORK

Decide what internet connection should be used for the installation. There are three types of internet connection that is possible to use for installation.

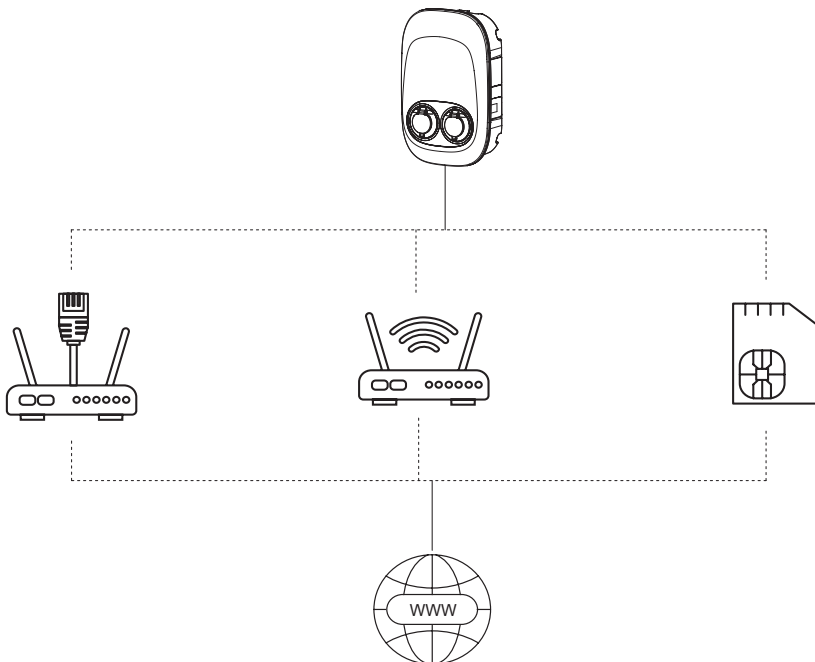

- Ethernet cable from the router/switch.
- Local WiFi connection from the building where the installation is set up.
- Built-in 4G/LTE module, support insert 4G SIM card.



The charging station is equipped with a built-in WiFi module that contributes to an easy installation. However, large distances or radio obstacles may require physical ethernet cable connections.

**Private scenario:** If you use the charging station in a private scenario, you can bind the charging station to the Evcharge APP directly, please go to page 14 to check the Evcharge user manual to get more information.

**Public scenario:** If you use the charging station in a public scenario, please connect your charging station to the Evcharge cloud platform by logging in and following the instructions, and then configure the charging station's network in AP mode as shown below.

**Connecting to a third platform:** If you want to connect the charging station to a third platform, please refer to the AP Mode Instruction below, and enter the correct server address.

### AP Mode Introduction

If you select WiFi for communication, you must first configure the internet for the charging station. The following steps show the configuration with AP mode.

#### Step 1: Activate the charging station's hotspot

Activate the hotspot of the charging station by restarting the power supply.

**i** The hotspot of the charging station remains available for 15 minutes after the charging station has been restarted.

#### Step 2: Establish a communication between the charging station and your phone

Switch your phone to airplane mode, and make sure that the WLAN is enabled.



Charging station

The charging station will send out a hotspot after it is restarted



WiFi

WiFi name: the serial number of the charging station  
WiFi password: see below



Phone

Select the WiFi hotspot sent out by the charging station and enter the password to connect.

**i** An 8-digit password which can be found on the last page of the manual or on the RCBO inside the charging station. The password is unique to the device and case sensitive.

#### Step 3: Login

To access the LOGIN page of AP mode, enter the IP address 192.168.4.1 in a browser, followed by the 4-digit network password (PIN number).

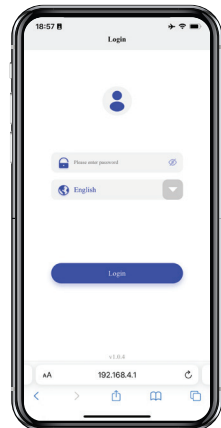

**i** The PIN number can be found on the RCBO and on the last page of the user manual.

## Step 4: Configure WiFi

After logging in, you will be prompted with the following interfaces:

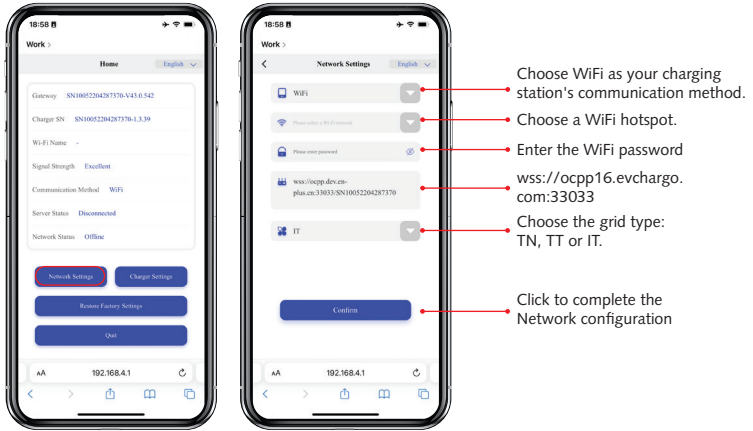

**i** wss://ocpp16.evcharge.com:33033 is an address that connects your charging station to a cloud management platform. If you want to connect your charger to a 3rd party's platform, you can enter the URL of the 3d party platform.

**i** Your charging station will automatically restart once the network configuration is complete, ending communication between your phone and the charger, at this point, your phone may automatically join to other WiFi hotspots, preventing you from accessing the network configuration interface. As a result, before accessing the network configuration interface, please ensure that your phone is connected to the charging station's WiFi hotspot.

## 7 CONDUCT A FUNCTION TEST

Use the vehicle simulation adapter or EV to conduct a functional test.

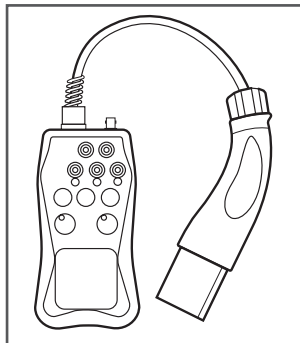

## 8 CONNECT THE CHARGING STATION TO EVCHARGO CLOUD

Evcharge cloud is a cloud platform for business operators to meet the needs for charging station monitoring and management, as well as smart and efficient operations and maintenance.

The platform account and password will be sent to your email.

For the instructions for Evcharge cloud, please scan the QR code below:



Instructions for Evcharge cloud

## 9 USE EVCHARGO APP TO CHARGE ELECTRIC VEHICLE

If you use the charging station in a private home scenario, you can use our App to control the charging session.

Download and install the latest app on your smartphone.

Follow the instructions on the app or scan the App instruction's QR code to complete wizard settings and parameter settings.



App download



App instructions

## 10 TROUBLESHOOTING

<b>Problems</b>	<b>LED Status</b>
Warning (Ground fault, tampering, etc.)	Solid yellow light
Relay adhesion	Solid red light
Leakage current fault	The LED blinks red once and then goes out for 3s, cycling.
CP fault	The LED blinks red twice and then goes out for 3s, cycling.
Over current fault	The LED blinks red three times and then goes out for 3s, cycling.
Input polarity reverse	The LED blinks red four times and then goes out for 3s, cycling.
Leakage current loop abnormal	The LED blinks red five times and then goes out for 3s, cycling.
Input terminal overtemperature	The LED blinks red six times and then goes out for 3s, cycling.
Relay overtemperature	The LED blinks red seven times and then goes out for 3s, cycling.
Over/Under voltage fault	The LED keeps solid yellow for 2s, then blinks red once and then goes out for 3s; cycling.
Over / Under frequency fault	The LED keeps solid yellow for 2s, then blinks red twice and then goes out for 3s; cycling.
Meter comm abnormal	The LED keeps solid yellow for 2s, then blinks red three times and then goes out for 3s; cycling.
Smart meter comm abnormal	The LED keeps solid yellow for 2s, then blinks red four times and then goes out for 3s; cycling.
CT fault	The LED keeps solid yellow for 2s, then blinks red five times and then goes out for 3s; cycling.
Charging connector lock abnormal	The LED keeps solid yellow for 2s, then blinks red six times and then goes out for 3s; cycling.
Charging connector current abnormal	The LED keeps solid yellow for 2s, then blinks red seven times and then goes out for 3s; cycling.

# PIN CODE

# **MALMBERGS**

---

Malmbergs Elektriska AB, PO Box 144, SE-692 23 Kumla, SWEDEN  
Phone: +46 19 58 77 00 info@malmbergs.com www.malmbergs.com