



Design: Hallvard Jakobsen

Flott veggarmatur med kryss som kan monteres både ute og inne. Finnes i varianter med integrert skumringsrelé. Utført i trykkstøpt, pulverlakkert aluminium, og skjerm i UV-stabilisert opalisert polykarbonat. Enkel montering med hurtigklemmer. To kabelinnganger, mulighet for både synlig og skjult kabling. Korrosjonsbeskyttet med 10 års garanti. Vandalsikker IP65/IK10.

Lysteknikk

Kompakt fluorescerende pære eller LED (utskiftbar)
230V
11,5W, 18W TC-D, 26W TC-D eller Lyskilde ikke inkludert
3000K
Ra>80
SDCM:3
L70/B50>50.000 at Ta=25°C
Lysspredning: 120°
Energiklasse: A+ eller Energiklasse: B

Styring

Ikke dimbar

Beskyttelse

Klasse I, Klasse II, IP65, Ta=25°C, CE, IK10

Optikk

Plast, opal

Materialer/Overflater

Armaturhus: Aluminium eller Rustfritt stål
Farge: Grafitt (RAL 7024), Hvit (RAL 9003) eller Sort (RAL 9004)
Optikk: UV-stabilisert polykarbonat

Montering og tilkobling

Utenpåliggende

Product- and environment images



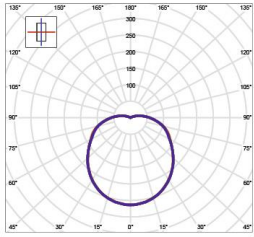



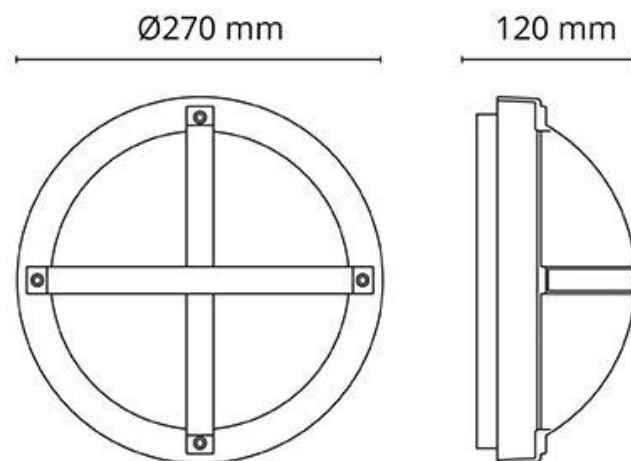











Solo 1100 LED 3000K
Efficiency: 100%
Lumen output: 613 lm



For line drawing dimensions please see each single article codes on next page

Artikkel	Beskyttelse	Styring	Montering/Tilkobling	Dimensjoner (mm)
1100				
 3104636 Solo 1100 Hvit 11,5W LED 3000K Ra>80 230V 610lm 56 lm/W SDCM:3 L70/B50>50.000 Lysspredning: 120°, Plast, opal	Klasse II IP65 IK10	Ikke dimbar	Utenpåliggende Hurtigklemme	Ø270
 3104356 Solo Skumring 1100 Hvit 11,5W LED 3000K Ra>80 230V 610lm 56 lm/W SDCM:3 L70/B50>50.000 Lysspredning: 120°, Plast, opal	Klasse II IP65 IK10	Ikke dimbar	Utenpåliggende Hurtigklemme	Ø270
 3104638 Solo 1100 Grafitt 11,5W LED 3000K Ra>80 230V 610lm 56 lm/W SDCM:3 L70/B50>50.000 Lysspredning: 120°, Plast, opal	Klasse II IP65 IK10	Ikke dimbar	Utenpåliggende Hurtigklemme	Ø270
 3104357 Solo Skumring 1100 Grafitt 11,5W LED 3000K Ra>80 230V 610lm 56 lm/W SDCM:3 L70/B50>50.000 Lysspredning: 120°, Plast, opal	Klasse II IP65 IK10	Ikke dimbar	Utenpåliggende Hurtigklemme	Ø270
 3104640 Solo 1100 Sort 11,5W LED 3000K Ra>80 230V 610lm 56 lm/W SDCM:3 L70/B50>50.000 Lysspredning: 120°, Plast, opal	Klasse II IP65 IK10	Ikke dimbar	Utenpåliggende Hurtigklemme	Ø270
3000K				
 3101302 Solo Hvit 18W TC-D Kompakt fluorescerende pære 3000K Ra>80 230V 10.000 Lysspredning: 120°, Plast, opal	Klasse I IP65 IK10	Ikke dimbar	Utenpåliggende Hurtigklemme	Ø270
 3101304 Solo Hvit 26W TC-D Kompakt fluorescerende pære 3000K Ra>80 230V 10.000 Lysspredning: 120°, Plast, opal	Klasse I IP65 IK10	Ikke dimbar	Utenpåliggende Hurtigklemme	Ø270

Artikkel	Beskyttelse	Styring	Montering/Tilkobling	Dimensjoner (mm)
 <p>3101310 Solo Sort 26W TC-D Kompakt fluorescerende pære 3000K Ra>80 230V 10.000 Lysspredning: 120°, Plast, opal</p>	<p>Klasse I IP65 IK10</p>	Ikke dimbar	<p>Utenpåliggende Hurtigklemme</p>	Ø270
Tilbehør				
 <p>3101599 Solo Ankerfeste Rustfritt stål Hurtigklemme</p>				W330 x H524
 <p>3101306 Solo E27 Sort 230V Lysspredning: 120°, Plast, opal</p>	<p>Klasse II IP65 IK10</p>		<p>Utenpåliggende Hurtigklemme</p>	Ø270
 <p>3101579 Stolpe Solo, Tanto, Uno & Primo Stolpe Sort Aluminium 230V</p>				L1000 x W290 x H220
 <p>3101312 Solo E27 Grafitt 230V Lysspredning: 120°, Plast, opal</p>	<p>Klasse II IP65 IK10</p>		<p>Utenpåliggende Hurtigklemme</p>	Ø270
 <p>3101589 Stolpe Solo, Tanto, Uno & Primo Stolpe Grafitt Aluminium 230V</p>				L1000 x W290 x H210
 <p>3101300 Solo E27 Hvit Lyskilde ikke inkludert 230V Lysspredning: 120°, Plast, opal</p>	<p>Klasse II IP65 IK10</p>		<p>Utenpåliggende Hurtigklemme</p>	Ø270